

FEATURES

• PNEUMATIC SEAT HEIGHT ADJUSTMENT

To raise seat remove pressure from seat and pull lever (1) up.

To lower seat height sit on chair and pull lever (1) up.

NOTE: It is normal for chair to slightly lower under body weight.

• LOCKING TILT ADJUSTMENT

For individual comfort, this chair has been equipped with an adjustment that will allow the user to change the tension of the tilting feature. Turn knob (2) clockwise to increase tension and counter-clockwise to decrease or ease the tension. To lock return chair to the upright position and push lever (1) in. To unlock pull lever (1) out.

NOTE: Be careful not to loosen back tilt adjustment knob completely.

• ARM HEIGHT ADJUSTMENT

To adjust arm height, push button (3) in to allow the arms to move up or down freely. Release the button (3) once the desired height is reached.

WARNING

1. Use this product only one person at a time.
2. Do not use this chair unless all bolts screws and knobs are securely tightened.
3. Check that all bolts screws and knobs are tight every three months or as needed.
4. Do not overturn back tilt knob when decreasing tension.
5. Dispose of packing material properly. Do not use plastic cover as head covering. It may cause suffocation.
6. Do not use chair as a stepladder.
7. Use this chair for its intended purpose only.
8. Use mild detergent only for cleaning.

OSP FURNITURE LIMITED PRODUCT WARRANTY

Design Lab Products









- 3 years on gaming desks and chairs
- Upholstery is not warranted against routine scratching and scuffing

**All warranties are limited to the original purchaser for normal commercial usage defined as a standard forty hour work week by persons weighing 250 lbs. or less. This warranty will not cover labor, freight or damage from misuse, abuse, negligence, alteration, accident, vandalism, rusting, acts of nature or any other event beyond the control of Office Star Products. The warranty does not cover cosmetic damage that may result from normal use. Liability for incidental or consequential damages is excluded. The user assumes all risk of injury resulting from use of this product. When usage is more than 40 hours per week, a two year warranty on all parts applies. Fabric and foam is warranted for one year. This warranty gives you specific legal rights, and you may also have other rights which vary from state to state.*





It is the customer's responsibility to prepay freight on any components returned to the factory. Return freight on components covered by warranty will be paid by Office Star Products.

Our quality standards are among the highest in the industry. Sometimes, no matter how hard we try, there are times when parts are damaged or missing. Our Parts Department will do everything possible to promptly remedy the problem. Contact us via e-mail parts@officestar.net, by Fax 1-909-930-5629, or toll free parts number 1-800-950-7262, Monday through Friday 8:00 a.m. - 5:00 p.m. Pacific Time.

HARDWARE LIST

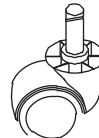
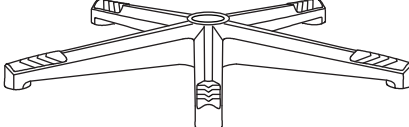
NO	DRAWING	DESCRIPTION	SIZE	QUANTITY
1		Flat Washer	6 x Ø x 18	4 PCS
2		Bolt	M6 x 20	2 PCS
3		Bolt	M8 x 16	3 PCS
4		Bolt	M8 x 25	6 PCS
5		Flat Washer	Ø8 x Ø18	9 PCS
6		Spring Washer	M8	9 PCS
7		Bolt	M6 x 30	2 PCS
8		Allen Wrench	M6	1 PC

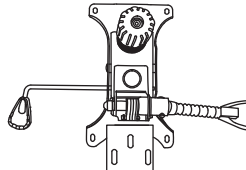
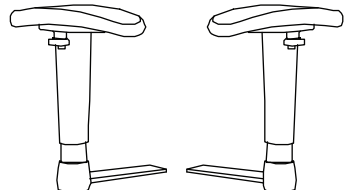
PARTS

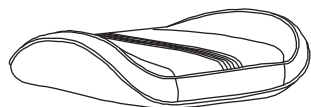
 (A) Caster (5 PCS)	 (B) Base (1 PC)
 (C) Pneumatic Cylinder (1 PC)	 (D) Bellows (1 PC)
 (E) Mechanism (1 PC)	 (F) Arms (L & R) (2 PCS)
 (G) Back Cushion (1 PC)	 (H) Seat Cushion (1 PC)

BOA225
BOA II GAMING CHAIR
ASSEMBLY INSTRUCTIONS

STEP 1

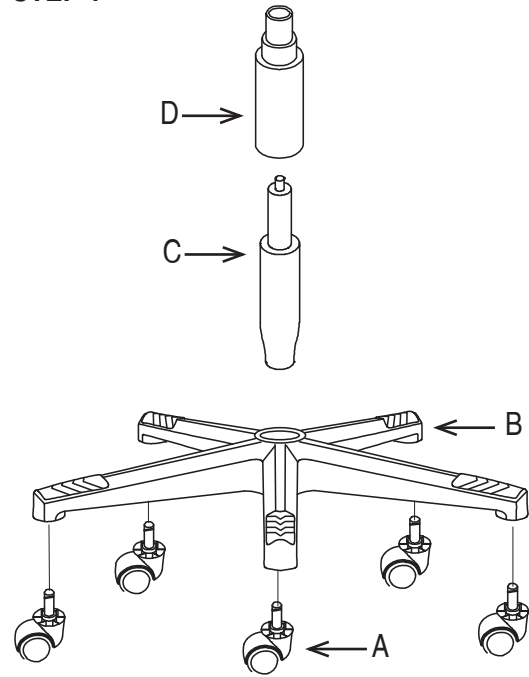

STEP 2

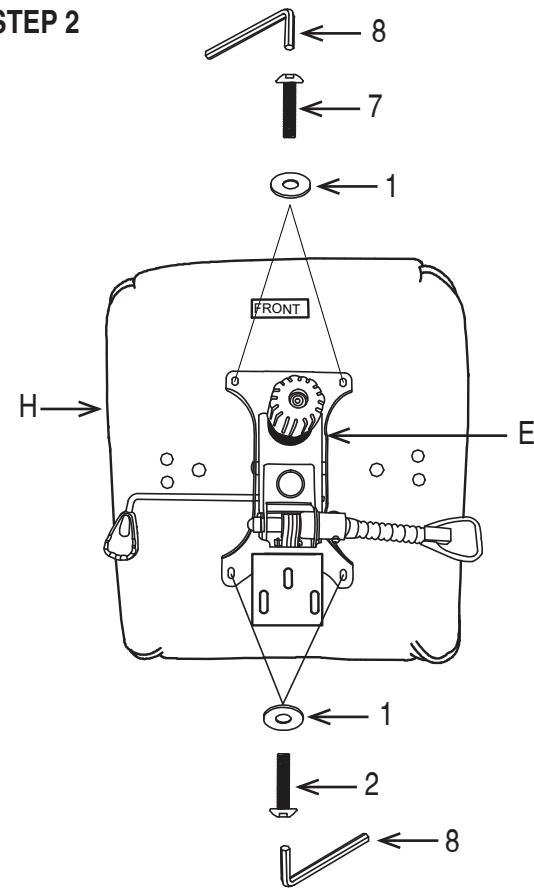

STEP 3

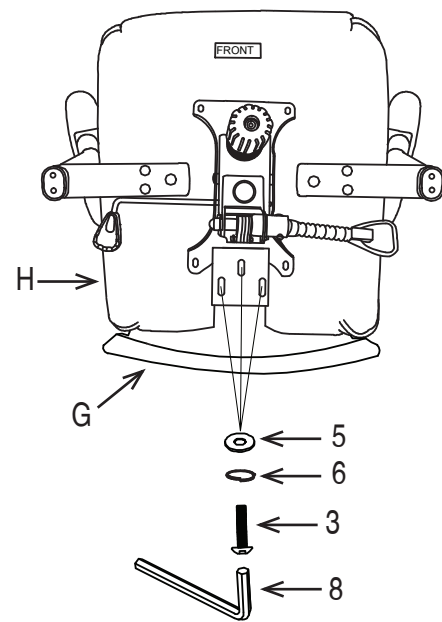

BOA225
BOA II GAMING CHAIR
ASSEMBLY INSTRUCTIONS

STEP 4

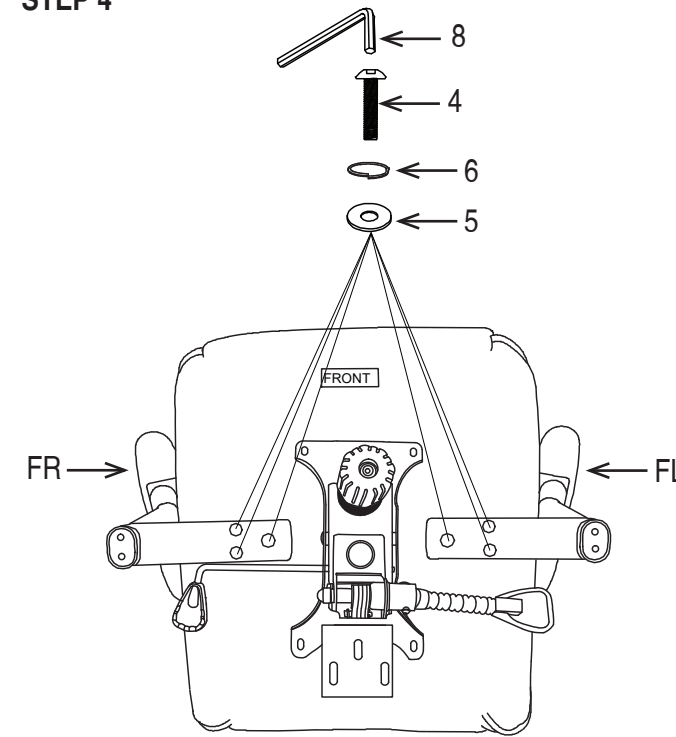

STEP 5

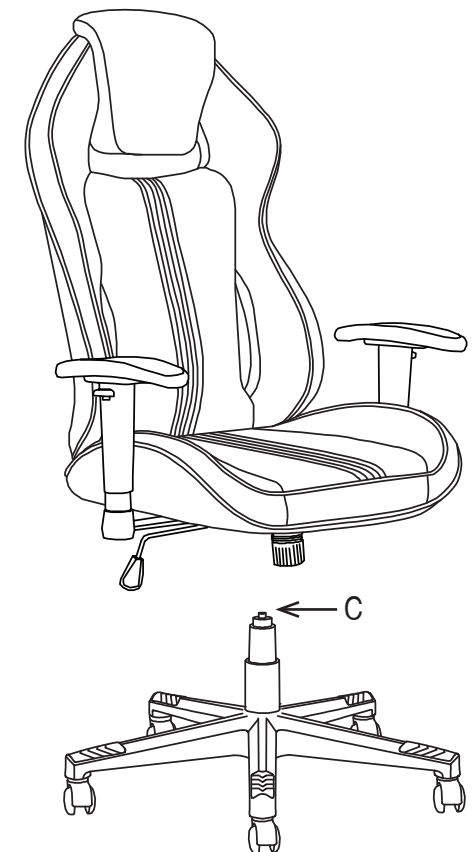

Remove all parts from carton, separate by part numbers indicated on parts list, and verify part quantities.

STEP 1 Insert five Casters (A) into Base (B), push hard until you feel or hear the Caster (A) snap into place. Insert Pneumatic Cylinder (C) into Base (A) and slip Bellows (D) over Pneumatic Cylinder (C).

STEP 2 Attach Mechanism (E) to Seat Cushion (H) using two Flat Washers (1) and two Bolts (7) for the front of Seat Cushion (H). Secure rear of Mechanism using two Flat Washers (1) and two Bolts (2). **FULLY TIGHTEN ALL BOLTS USING ALLEN WRENCH (8).**

STEP 3 Attach Back Cushion (G) to rear of Seat Cushion (H) using three Flat Washers (5), three Spring Washers (6) and three Bolts (3). **FULLY TIGHTEN ALL BOLTS USING ALLEN WRENCH (8).**

STEP 4 Attach Arms (FL & FR) to Seat Cushion (H) using three Flat Washers (5), three Spring Washers (6) and three Bolts (4) for each arm. **FULLY TIGHTEN ALL BOLTS USING ALLEN WRENCH (8).**

STEP 5 Place the assembled seat on top of Pneumatic Cylinder (C) and apply downward pressure.